

E3-R(WT)

PIR Sensor + WiFi & RF LED Controller

Features

- WiFi & RF RGB/CCT/DIM 3-in-1 PIR motion sensor LED controller with daylight detection.
- 3 button operation, 6 LED indicator, 3 work modes, 3 level sensitivity, 5 level dimmer, 6 level timer.
- Tuya smart APP cloud control, support on/off, RGB color, color temperature and brightness adjustment, timer run, scene edit and music play function.
- Voice control, support for Amazon Alexa, Google Assistant, Tmall Genie and Xiaodu smart speakers.
- Built in 15 static and 5 dynamic modes, including jump or gradual change style.
- Smooth dimming, no flicker.
- Two light off methods are available, the light goes out or stays low when the person leaves.
- Optional RF 2.4G single-zone or multi-zone DIM/CCT/RGB remote control.
- Work as RF remote, output RF 2.4G signal, matched with RF LED controller or RF dimmable LED driver optional.
- 3M tape installation, easy and convenient.
- Suitable for kitchen, cabinets, stairs, bedrooms, closets, living rooms, aisles and so on.



Sensor

Mechanical Structures and Installations

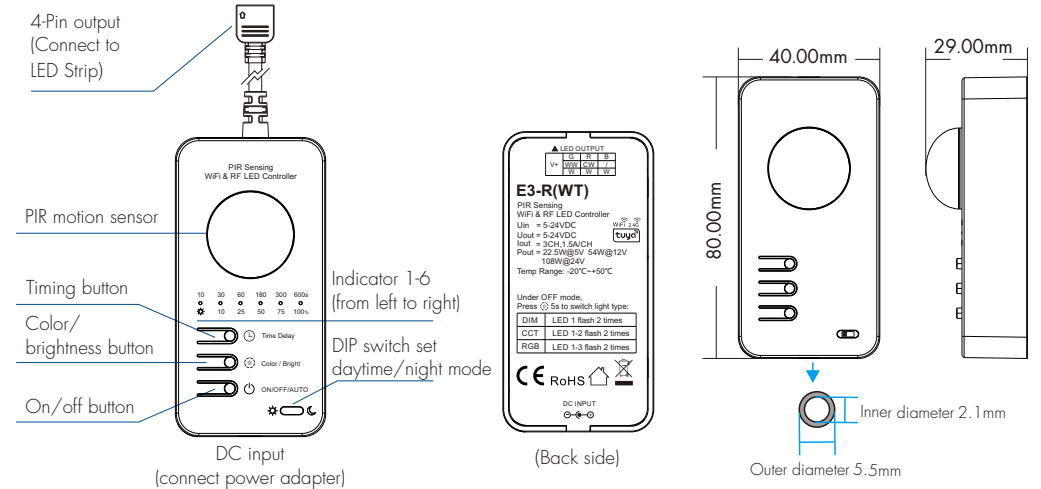

CE RoHS

Technical Parameters

Input and Output		Sensor date		Safety and EMC	
Input voltage	5-24VDC	Sensitivity angle	120°	EMC standard	EN IEC 55015/ EN IEC 61547 ETSI EN301489-1/-3/-17
Output voltage	5-24VDC	Sensing range	2-6.5m	Safety standard	EN 61347-1/-2
Output current	3CH, 1.5A/CH	Dimming data		Radio equipment	ETSI EN300 328 ETSI EN 300 440
Output power	22.5W@5V 54W@12V 108W@24V	Input signal	PIR sensor + WiFi + RF 2.4GHz	Certification	CE RoHs
		Control distance	30m(Barrier-free space)	Environment	
		Dimming gray scale	256 levels	Operation temperature	Ta: -20°C ~ +50°C
Warranty and Protection		Dimming range	10-100%	Case temperature (Max.)	Tc: +85°C
Warranty	5 years	Package		IP rating	IP20
Protection	Anti-reverse Over-heat	Size	L100 x W46 x H38mm		
		Gross weight	0.060kg		

Wiring Diagram

- Apply to RGB

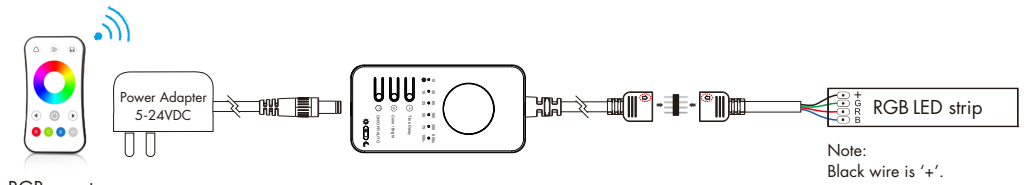

RGB remote

- Apply to CCT

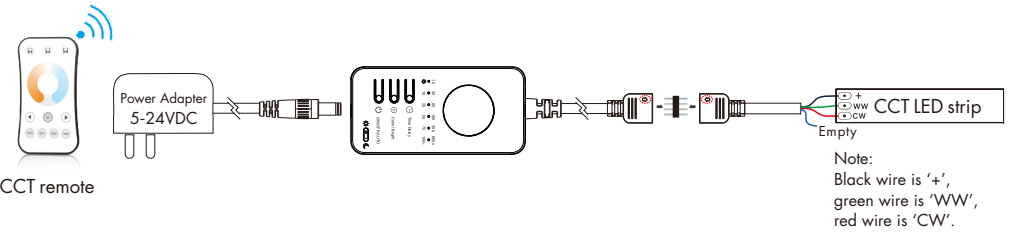

CCT remote

- Apply to DIM

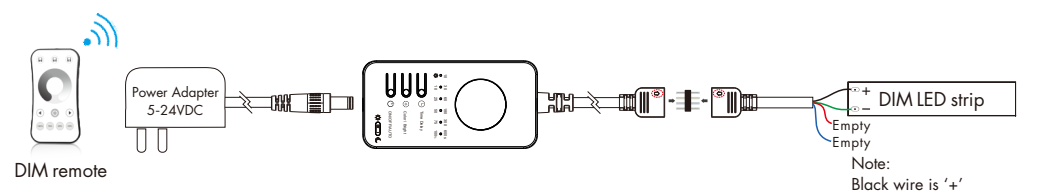

DIM remote

System Wiring

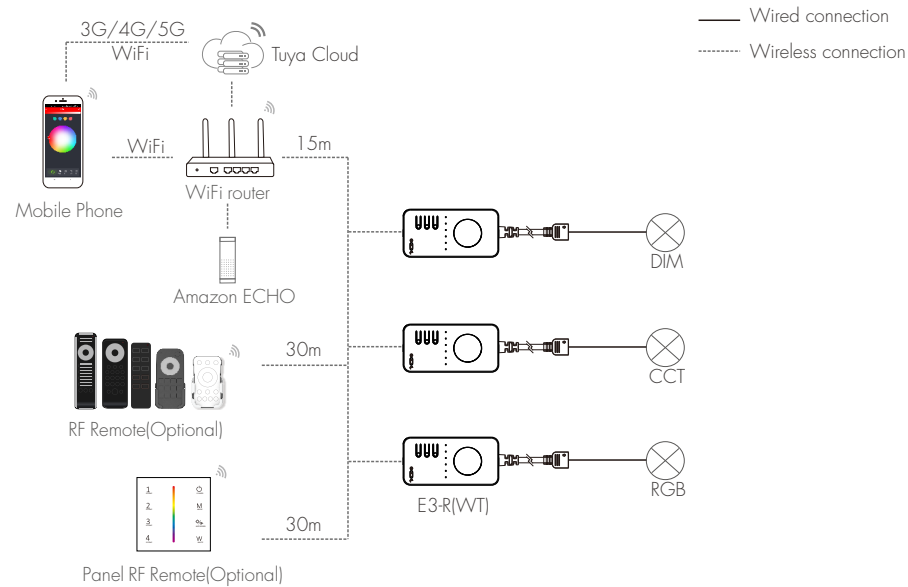

Note:

1. The above distance is measured in spacious (no obstacle) environment, Please refer to the actual test distance before installation.
2. Please check if the WiFi router net in 2.4G band, the 5G band is not available, and do not hide your router network.
3. Please keep the distance between LED driver and router close, and check the WiFi signals.
4. WiFi signal strength detection: open the main interface of device, click enter the device interface, click "check device network" for testing.

Button Operation

1. Three working modes

Short press button to switch 3 working modes sequentially: light on, light off, auto-sensing mode(default).

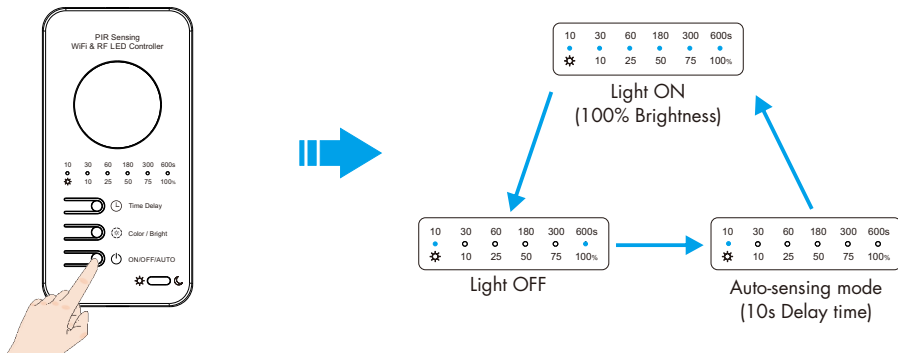

Light OFF mode

In light off mode, the LED strip is off, and indicator 1 and indicator 6 are on.

In light off mode, long press button for 5s to switch three light type (DIM/CCT/RGB).

When indicator 1 flashes twice, switch to DIM type;

When indicator 1-2 flash twice, switch to CCT type;

When indicator 1-3 flash twice, switch to RGB type (default).

Light ON mode

In light on mode, the LED strip is always on. Press button to adjust the light color or brightness.

RGB type: Short press button to switch 15 static color sequentially (color wheel 12 color, warm white, natural white, cool white) and 5 dynamic modes.

In static mode, long press button for 1-6s to continuously adjust the brightness 10-100%.

In dynamic mode, long press button for 2s to switch 5 dynamic speeds.

CCT type: Short press button to switch 5 color temperatures (warm white, natural white, cool white), long press button for 1-6s to adjust 10%-100% brightness continuously.

DIM type: Short press button to switch 5 levels of brightness in sequence: 10%, 25%, 50%, 75%, 100%.

Indicators 1-6 indicate the current brightness:

10% (indicator 1-2 on), 25% (indicator 1-3 on), 50% (indicator 1-4 on), 75% (indicator 1-5 on), 100% (indicator 1-6 on).

If you short press button in the light-on mode, it will automatically switch to auto-sensing mode.

The light on mode is applied in the kitchen and other places where long time lighting is needed, it can be used with RF remote control.

No.	Name
1	RGB jump
2	RGB smooth
3	6 color jump
4	6 color smooth
5	Yellow cyan purple smooth

RGB dynamic mode list

Auto-sensing mode

In auto-sensing mode, turn on the light when the PIR sensing probe detects human movement, and turn off the light with automatic delay after the person leaves.

In auto-sensing mode, set the sensing delay off time through button(10-600s).

Short press button to switch 6 levels of delay time: 10s (indicator 1 on), 30s (indicator 2 on), 60s (indicator 3 on), 180s (indicator 4 on), 300s (indicator 5 on), 600s (indicator 6 on).

Two kinds of sensor light off mode optional, people go light off or people go light keep low brightness (10%), factory default people go light off.

In auto-sensing mode, long press and button for 2s to switch two light off modes.

When indicator 1-2 flashes 3 times, it set to keep low brightness, i.e. after the end of sensing delay, the light will remain 10% brightness.

When Indicator 1 blinks 3 times, set the mode of the light going out when the person leaves.

In auto-sensing mode, press button, switch to light on mode, and short press button again or no key operation for 3s, it will resume auto-sensing mode.



Auto-sensing mode is used in staircases, corridors, cupboards, bedrooms and other places where need to light on by sensing.

Note: (1) When keeping the low brightness mode, the brightness adjustment range automatically changes to 25%-100%.



(2) When turning on auto-sensing mode, it is recommended to turn on daylight detection at the same time.

2. Daylight detection

DIP switch set daytime or night mode.

- ☼  ☾ Daytime mode with daylight sensing turned off, i.e. 24 hour use of IR human sensing.
- ☼  ☽ Night mode with daylight sensing turned on, the light will be turned on only when the ambient light is less than the daylight sensing threshold. The daylight sensing threshold is fixed at 50 lux by default.



3. Setting PIR sensitivity

Long press  and  button at the same time for more than 2s to set the PIR sensing sensitivity:
Long press for 2s, set to high sensitivity (sensing distance 4-6.5 meters), all indicators flash 1 time;
Long press for 5s, set to medium sensitivity (sensing distance 3-6 meters), all indicators flash 2 times;
Long press for 10 seconds, set to low sensitivity (sensing distance 2-5 meters), all indicators flash 3 times.

4. Setting light off fade time

The light on fade time is fixed 1s, the light off fade time can be set 1, 2, 3s.
In the light off mode, long press  button for 2s to switch the three light off fade time in sequence:
1 second light off fade time, indicator 1 blinks once;
2 second light off fade time, indicator 1-2 blinks once;
3 second light off fade time, indicator 1-3 blinks once.

5. Restore factory settings



Long press  and  button at the same time for 1.5s to restore the factory settings, all the indicator lights flash 2 times.
Factory default parameters: auto-sensing mode, PIR sensing high sensitivity, RGB light type, light off after people leave, sensing delay off time 10s.

Match Remote Control (Optional)

The PIR motion sensor dimming controller E3-R(WT) can match with RF remote to realize both sensor control and remote control at the same time.

When set to auto-sensing mode by  button, the light can also be adjusted by the remote control, and the sensor dimmer controller maintains the auto-sensing mode unchanged.

Use key matching

Match: Long press  and  button for 2s, all indicators flash 1 time, it will enter the matching remote control status, immediately press on/off key (single zone remote) or zone key (multiple zone remote) of the remote.
All indicators blinks 3 times means match is successful.

Delete: Long press  and  button for 10s, all indicators blinks 5 times, means all match were deleted.

Use Power Restart

Match: Switch off the power of controller, then switch on power, repeat again.
Immediately short press on/off key (single zone remote) or zone key (multiple zone remote) 3 times on the remote.
The light blinks 3 times means match is successful.

Delete: Switch off the power of controller, then switch on power, repeat again.
Immediately short press on/off key (single zone remote) or zone key (multiple zone remote) 5 times on the remote.
The light blinks 5 times means all matched remote were deleted.

Work as RF Remote

The PIR motion sensor dimming controller E3-R(WT) can be matched with one or multiple RF LED controller or RF dimmable LED driver, including single color, dual color, RGB light type. Turn on or turn off the other light by motion detection.
End user can choose the suitable match/delete ways. Two options are offered for selection.

Use the controller's Match key

Match: Short press the match key of the controller, immediately press  button of E3-R(WT).
The LED indicator of controller flash fast means match is successful.

Delete: Long press the match key of the controller for 5s to delete all match,
the LED indicator flash fast means all matched were deleted.

Use Power Restart

Match: Switch off power of the controller, then switch on power, repeat again.
Immediately short press  button of E3-R(WT) 3 times.
The light blinks 3 times means match is successful.



Delete: Switch off power of the controller, then switch on power, repeat again.
Immediately short press  button of E3-R(WT) 5 times.
The light blinks 5 times means all matched were deleted.

Tuya Smart APP Network Connection

• Download and Open APP

Search for "Tuya Smart/Smart Life APP" in the APP store, or scan the QR code on the right to download the APP.
Register and login after installation.

• APP Pairing Network

Long press  and  button for 5s to clear the previous network connection, all indicator blinks 1 time, enter Tuya WiFi config mode, the output LED strip flash 10 times.

Repeat power on and off for 5 consecutive times, also clear previous network connection, enter WiFi config mode.

If Tuya Smart APP network connection succeed,
you can find RGBc device (or other DIMc, CCTc device) in Tuya Smart APP.

When controlling the light fixture with Tuya Smart/Smart Life APP,
the network connection is poor, you can control the light fixture with Bluetooth within the Bluetooth control range.
Note: The fixture cannot be directly controlled by Bluetooth without WiFi configuration.



Smart Life



Tuya Smart



Tuya Smart APP Interface

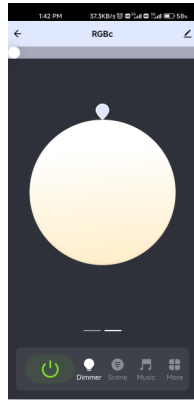

White interface

Touch brightness slide, get RGB mixed white firstly, then to adjust white brightness.

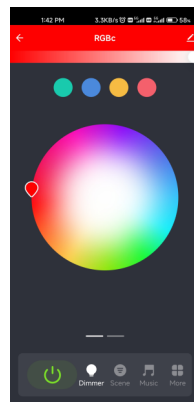

Color interface

Touch color circle to adjust static RGB color.
Touch brightness slide to adjust color brightness.

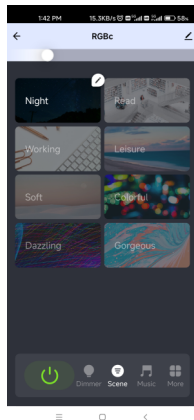

Scene interface

The 1-4 scene is static color.
the inner color of these scene can be editable.

The 5-8 scene is dynamic mode,
such as green fade in and fade out, RGB jump,
6 color jump, 6 color smooth.

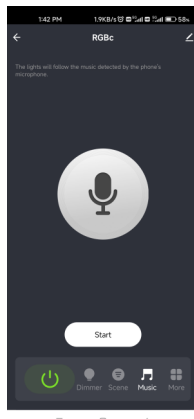

Music, Timer, Schedule

The music play can use smart phone music player or micro-phone as music signal input.

The Schedule key can add multiple timers to turn on or turn off light according to different time periods.

The Timer key can turn on or turn off light in the next 24 hours.

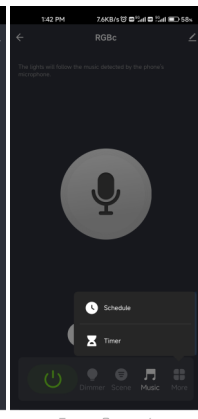

Stair Light Applications



(Auto sensing mode installation diagram, for reference only)

When using staircase lights, install a set of sensor dimming controllers and light strips on both the upper and lower sides of the staircase.
Two sensor dimming controllers are set with the same delay off time and matched with each other.

When going upstairs or downstairs, the lights on both sides of the staircase will switch on and off simultaneously.

WARNING: Two sensor dimming controller must not be connected together to control the same LED strip.

Notice for installation of PIR sensor

1. If the sensor is exposed to direct sunlight, interference signal will be introduced.
2. The sensor should be installed in a dry environment and keep away from windows, air conditioner and fans.
3. Make sure that the sensor stays away from heat source, such as countertops, kitchen appliances which generate hot steam, walls and windows in direct sunlight, air conditioner, heating, refrigerators, stoves and so on.
4. There should not be shelter(screen, furniture, large bonsai) within the range of detection.

Packing List



LED Controller
1 pcs

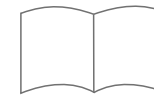

User Manual
1 pcs



Extension Cable
(1.2m)
1 pcs



4-Pin Plug
1 pcs